

Evolv DNA 60

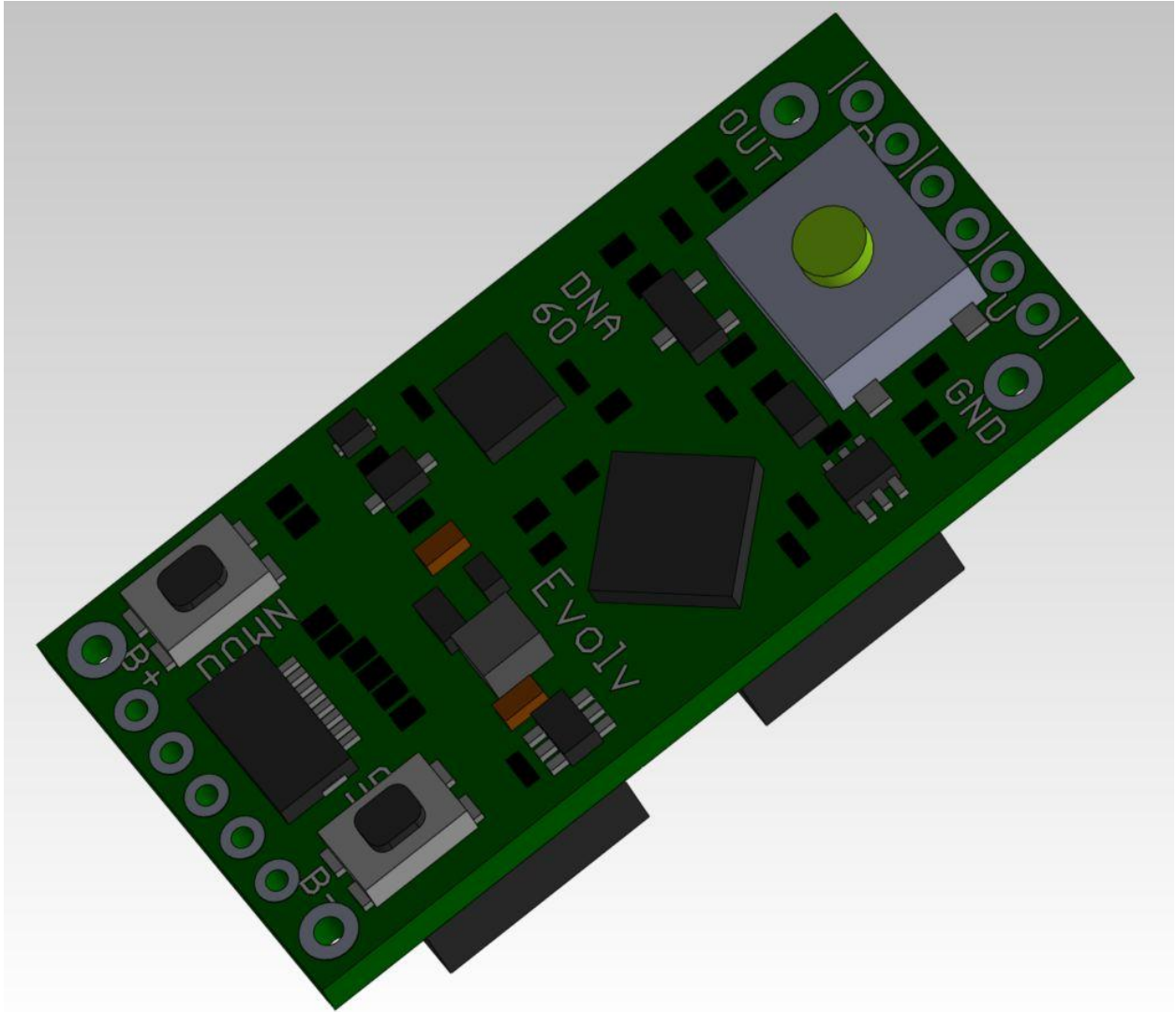

60 Watt Variable Power Module with Temperature Protection and USB

The DNA 60 is a power regulated digital switch-mode DC-DC converter for personal vaporizers. It features Evolv's patented Wattage Control, Temperature Protection, Preheat, OLED Screen, Reverse Polarity Protection, and waterproof onboard buttons. The DNA 60 runs from a single lithium polymer or lithium ion battery, and features battery monitoring. A Micro USB satellite board for 1 Amp charging and data connection to customize or monitor the user experience via EWrite is also available separately.

Specifications

	Minimum	Typical	Max
Output Power	1 Watt		60 Watts
Output Voltage	.2 Volt		9 Volts
Output Current, continuous			22.0 Amps
Output Current, instantaneous peak			
Atomizer Resistance, temperature sensing wire, cold	See Graph	.15 Ohm	See Graph
Atomizer Resistance, Kanthal wire	See Graph	.25 Ohm	See Graph
Temperature Limit	200°F	450°F	600°F
Input Voltage	3.0 Volts	3.7 Volts	4.2 Volts
Input Current	.5 Amps	12.0 Amps	25.0 Amps
Input Current, pulse			32.0 Amps
Screen On Current		26mA	
Quiescent Current		7mA	
Power Down Current		0mA	
Efficiency		85%	
Weight		15g	
Footprint		.65" x 1.30"	
Thickness		.35"	
Screen size		.91" OLED	

Contents

Specifications	2
Temperature Protection	4
Preheat.....	4
Attaching a New Atomizer	5
Output Power.....	5
Operation	6
Display.....	6
Alternate display items	6
Modes	7
Profiles	8
Coil Materials	8
Error Messages	9
Auto power down	9
Charger.....	10
Battery monitoring.....	10
Escribe	10
Pinout (shown bottom side)	11
Wiring.....	13
Recommended wire sizes	13
Reverse Polarity Protection	13
External component recommendations	13
Mounting.....	14
Mechanical Dimensions	15

Temperature Protection

The DNA 60 directly measures and limits the temperature of the heating coil during operation. By preventing the coil from becoming too hot regardless of fluid, wicking or airflow, a variety of undesirable situations can be prevented. For example, appropriate temperature settings will prevent the wicking material from charring, which compromises taste and introduces unintended chemicals into the vapor. Appropriate temperature settings will also reduce the breakdown of flavoring and base liquid components, which could impact taste or safety.

Evolv's Temperature Protection Technology requires a heating coil made from Nickel 200 alloy or other materials with a well-defined temperature coefficient of resistance, rather than Nickel Chromium or Kanthal alloys. If the temperature reaches the maximum value, the wattage applied to the atomizer coil is reduced to prevent overheating. Please note that the temperature reading is the average temperature of the atomizer coil, and care should be taken to construct the heating coil so that the temperature is uniform, without hot or cold spots.

Because wattage, not temperature controls vapor volume, large vapor volumes can be produced without unnecessarily high temperatures. Temperature Protection is most helpful if the atomizer begins to dry out, the user pauses during a puff, the beginning or end of the puff, or if the wattage setting is inappropriate for the attached atomizer.

In normal operation, when the device is not firing the maximum temperature setting is displayed on the screen. When the device is firing, the actual average temperature of the coil is displayed on the screen.

By default, the Temperature Protection setting is 450° Fahrenheit. To change the limit

- 1) Lock the device by pressing the Fire button five times.
- 2) Hold down the UP and DOWN adjust buttons for two seconds.
- 3) After two seconds, the maximum temperature will be displayed, and the UP and DOWN buttons should be released.
- 4) Use the UP and DOWN buttons to adjust the maximum temperature
- 5) When the display shows the desired maximum temperature, press the Fire button to exit temperature adjust mode.

The maximum temperature is adjustable between 200° Fahrenheit and 600° Fahrenheit. To disable the temperature protection entirely, adjust the limit up to 600 degrees, then press the UP button one additional time. The temperature limit will read OFF.

To switch to Celsius temperature, adjust temperature down to 200° Fahrenheit, then press the DOWN button one additional time. The temperature will switch to reading and adjusting in Celsius.

Preheat

When the DNA 60 is used with a temperature sensing atomizer, an additional feature called Preheat is activated. No vapor is produced when the temperature is below the boiling point of the liquid. Preheat applies extra power until the heating coil is up to operating temperature to shorten the

delay between pressing the fire button and generating vapor. Because preheat is temperature based, it will not overheat or burn the vapor.

Attaching a New Atomizer

The DNA 60 uses the resistance of the atomizer to calculate the temperature of the heating coil. It continually looks to see whether a new or changed atomizer has been connected. If you are using temperature protection, be careful to only attach new atomizers that have cooled to room temperature. If a new atomizer is attached to the DNA 60 before it has cooled down, the temperature may read and protect incorrectly until the new atomizer cools.

When you connect a new atomizer or disconnect and reconnect your existing atomizer, the DNA 60 will prompt you to confirm this change. When you fire the first time, before activating the DNA 60 will prompt "New Coil? UP YES/DOWN NO". When you see this prompt, if you have attached a new atomizer, press the UP button. If you have disconnected and reconnected the same atomizer, press the DOWN button.

Output Power

The following graphs show the output power range of the DNA 60 as a function of the coil resistance.

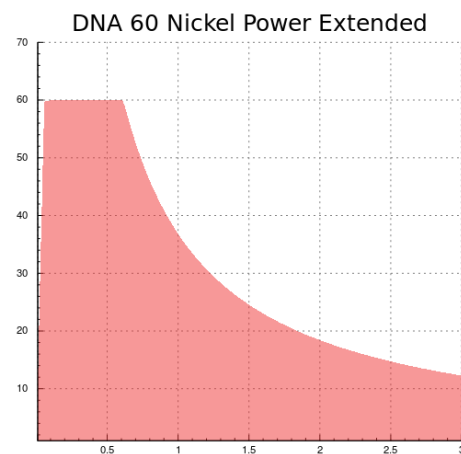
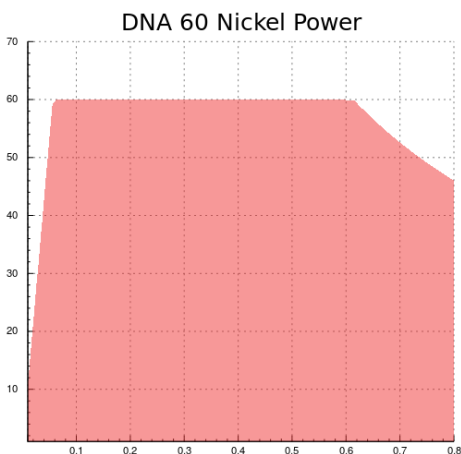
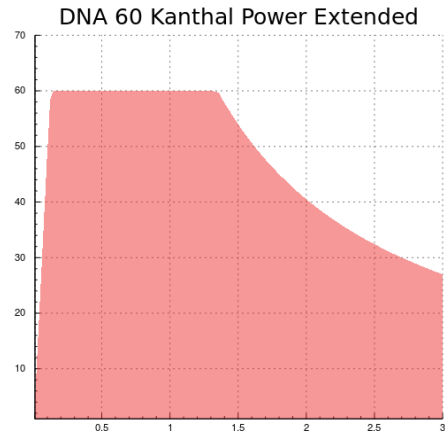
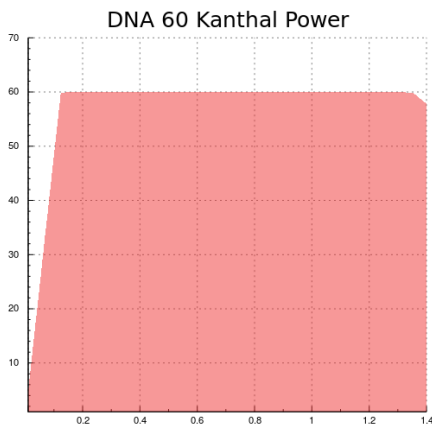

Operation

Basic operation of the DNA 60 is as follows. To wake the device from power off state, tap the Fire button. To generate vapor, press the Fire button. To change the wattage setting for more or less vapor, click or hold the Up and Down buttons.

Display

The DNA 60 has a small .91" diagonal OLED screen. The screen is attached to the main board by a flexible cable, allowing freedom in the design of your device. The screen's default position is on top of the board, between the fire and adjust buttons. This allows for easy assembly. The screen connects to the board with a ZIF connector, so alternate placement is possible. It is also possible to order screens with custom length and shape flexible cables, allowing screen placement anywhere in the device. Please use caution when handling the screen and design the device so that the cable will be secured or strain relieved in operation.

Watt setting: The power level currently set on the DNA 60.

Battery indicator: The current state of charge of the battery.

Temperature display: When not firing, the maximum heating coil temperature setting. While firing, the actual temperature of the heating coil is displayed.

Volts display: The output voltage being supplied to the atomizer.

Ohms display: The resistance of the atomizer attached to the device. When using a temperature sensing coil, this is the normalized resistance of the coil at 70°F

Alternate display items

Any of the following items can be displayed during operation or charging in lieu of the standard Ohms, Profile Name or Temperature displays. The Escribe PC software is used to change the display settings. A detailed description of each item can be found in the Escribe manual

Battery Charge	Output Current	Average Output Power of the most recent puff
Battery Pack Voltage	Output Voltage	Average Temperature of the most recent puff
Room Temperature	Material Name	Total Energy of the most recent puff
Puff Count	Board Temperature	Duration of the most recent puff

Modes

Locked mode: Pressing the fire button five times with less than .7 seconds between presses will cause the device to enter Locked mode. In Locked mode, the device will not fire and the output power will not adjust accidentally. While in Locked mode, the screen will be off, except that pressing a button will show “Locked, Click 5X”. To exit Locked mode, press the fire button 5 times.

Stealth mode: While locked, holding the fire and down buttons simultaneously for five seconds will switch to stealth mode. In this mode the display is off. It will still show error and lock messages. To switch back to normal display mode, hold down the fire and down buttons simultaneously for 5 seconds. This setting is stored to internal flash memory, and remains if power is removed.

Power Locked mode: Holding down both the up and down buttons for two seconds will place the device in Power Locked mode. In this mode, the mod will operate normally, but you will not be able to change the power setting. This mode prevents accidental power level changes due to the buttons being pressed while in a pocket. To exit Power Locked mode, hold the up and down buttons for two seconds.

Resistance lock: The DNA 60 relies on the cold resistance of the atomizer to measure temperature accurately. If the connection is not stable or if you find the measured resistance drifts with time, it may be desirable to lock the atomizer resistance. To do so, while locked hold both the Fire and Up buttons for two seconds to enter Resistance Lock mode. In this mode, the DNA 60 will use the present atomizer cold resistance without refinement until the atomizer is disconnected or the resistance lock is disabled. A lock symbol will replace the ohm symbol on the display. To disable resistance lock, repeat the procedure to lock it.

Max Temperature Adjust: From Locked Mode, holding down both the up and down buttons for two seconds will place the device in Max Temperature Adjust mode. Once this mode is entered, the max temperature will be displayed. The up and down buttons are used to adjust the max temperature. To save the new temperature setting and exit, press the Fire button.

Profiles

The DNA 60 allows you to save and select between eight groups of output settings. Each group of output settings is called a Profile. To switch between profiles, put the DNA 60 into Power Locked mode by pressing and holding both the up and down buttons simultaneously for two seconds. From power locked mode, to cycle between profiles, double click the Up or Down button. To select the displayed profile, press the fire button.

The coil material for each Profile can be changed directly on the device for any material that exists in the Materials Repository. To change the currently selected Profile's material, press the Fire button five times to Lock the device. With the device Locked, hold the Up, Down, and Fire buttons simultaneously for two seconds. Then, use the Up and Down buttons to cycle through materials, when the desired material is displayed press the Fire button to confirm your selection.

Evolv recommends setting up one profile for each atomizer that you regularly use with the DNA 60. It is much faster to switch profiles than it is to set up the settings for the atomizer again.

Coil Materials

Each profile contains an output power setting and a maximum temperature setting. These can be adjusted on the device, and will be saved when a different profile is selected. Additionally, the resistance lock setting and value for each atomizer is saved in the profile, which can alleviate temperature inaccuracies stemming from attaching atomizers before they have completely cooled. Many more output settings, including the coil material and preheat settings can be adjusted on a per-profile basis using the Escribe PC software.

Error Messages

The DNA 60 will indicate a variety of error states.

Check Atomizer: The DNA does not detect an atomizer, the atomizer has shorted out, or the atomizer resistance is incorrect for the power setting.

Shorted: The atomizer or wiring are short circuited.

Weak Battery: The battery needs to be charged, or a higher amp rate battery needs to be used. If this happens, the DNA 60 will continue to fire the atomizer, but will not be able to provide the desired wattage. The Weak Battery message will continue to flash for a few seconds after the end of puff.

Check Battery: The battery is deeply discharged and needs to be charged, or is damaged. If this happens, the DNA 60 will not fire the atomizer. The Check Battery message will continue to flash for a few seconds after attempting to fire the device. User should remove and replace the battery.

Temperature Protected: The heating coil reached the maximum allowed temperature during the puff. If this happens, the DNA 60 will continue to fire, but will not be able to provide the desired wattage.

Ohms Too High: The resistance of the atomizer coil is too high for the current wattage setting. If this happens, the DNA 60 will continue to fire, but will not be able to provide the desired wattage. The Ohms Too High message will continue to flash for a few seconds after the end of puff.

Ohms Too Low: The resistance of the atomizer coil is too low for the current wattage setting. If this happens, the DNA 60 will continue to fire, but will not be able to provide the desired wattage. The Ohms Too Low message will continue to flash for a few seconds after the end of puff.

Too Hot: The DNA 60 has onboard temperature sensing. It will shut down and display this message if the internal board temperature becomes excessive.

Auto power down

The screen will be at full brightness while firing. After 10 seconds with no button presses, the screen will dim. 30 seconds after the last button press, the screen will fade out and the device will go into sleep mode. To wake the device, press the fire button.

Charger

An external 1A Micro USB charger for the DNA 60 is available separately. It automatically detects the type of USB power supply it is connected to, so it can be plugged into standard PC USB ports or higher power chargers. It also includes pinouts for a data connection to utilize EScribe. Please see the Evolv website for more information.

Battery monitoring

The DNA 60 contains a battery management system that continuously monitors the state and health of the battery both under load and while idle.

EScribe

EScribe is a software package used to configure, monitor and modify the operation of your DNA 60. It installs on a Windows PC and connects to your DNA 60 using the USB port. EScribe has a separate manual and tutorials which can be found on Evolv's site.

Pinout (shown bottom side)

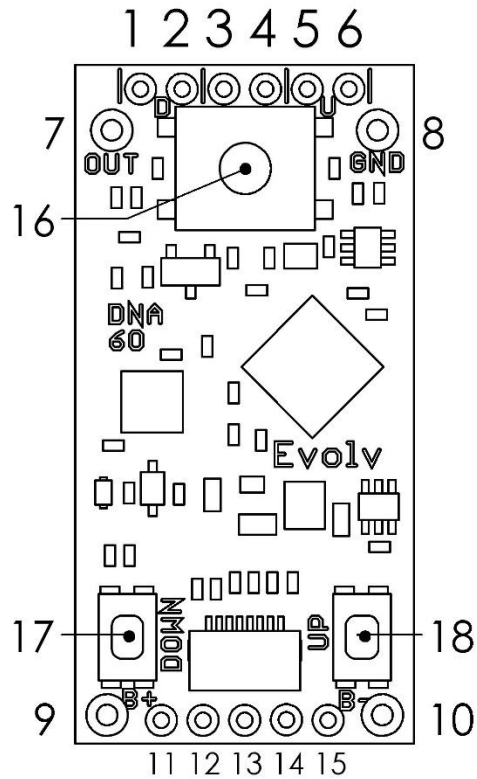

Pin Number	Pin Name	Function
1	Down +	Positive side of the power down button.
2	Down -	Negative side of the power down button.
3	Fire +	Positive side of the fire button.
4	Fire -	Negative side of the fire button.
5	Up -	Negative side of the power up button.
6	Up +	Positive side of the power up button.
7	Power Output	Atomizer output
8	Output Ground	Atomizer ground (Connects internally to 10)
9	Battery Input +	Battery positive
10	Battery Input -	Battery negative
11	Charger Output +	USB power positive
12	Charger/USB -	USB power negative
13	USB DM	USB data negative
14	USB DP	USB data positive
15	USB Vdetect	Connect to USB Vbus though a 10k ohm resistor if not using Evolv's charger board
16	Fire Button	
17	Down Button	
18	Up Button	

Wiring

The atomizer positive is connected to OUT, and the atomizer negative to GND. The battery is connected to the B+ and B- terminals. It is important to use appropriately sized wire when using the DNA. Too small wire will not perform well, and significantly undersized wire can burn out.

Recommended wire sizes			
	Minimum size	Recommended size	Maximum size
Battery, silicone insulated	20 gauge	18 gauge	16 gauge
Battery, PVC Insulated	18 gauge	16 gauge	14 gauge
Output, silicone insulated	16 gauge	14 gauge	12 gauge
Switches, if used	28 gauge	24 gauge	22 gauge

Reverse Polarity Protection

The DNA 60 includes built in Reverse Polarity Protection to protect the user, board, device, and battery in the event that a battery is inserted backwards.

External component recommendations

The DNA 60 is a self-contained power regulator which does not require external components for its user interface. However, it does support the use of external interface components if desired.

Fire button:

Use a momentary on, normally open type switch or button. A standard pushbutton switch is appropriate. The switch is a logic function – all power switching is handled with transistors inside the DNA module, so the switch does not need to be rated for power. A waterproof or processed sealed switch is recommended. Please use caution, as the positive side of the fire button connects directly to positive battery voltage.

Up/Down buttons:

The small onboard buttons labeled UP and DOWN allow the user to increase or decrease the power level in .1 Watt increments. Alternatively, remote normally open type switches or buttons can be attached to the UP and DOWN mounting holes for customization.

Battery:

The DNA 60 runs from a single lithium polymer type battery pack or round lithium ion type battery. The DNA 60 can use multiple cells in a parallel type wiring configuration as long as the maximum input voltage is 4.2v.

Mounting

The DNA 60 has onboard switches for adjusting the power level and activating the output. Each of these functions also has optional through-hole pads for using remote buttons.

The DNA 60 should be mounted in a way that retains the board firmly in place with no movement possible. This will reduce or eliminate the possibility of any connections failing over time.

Mechanical Dimensions

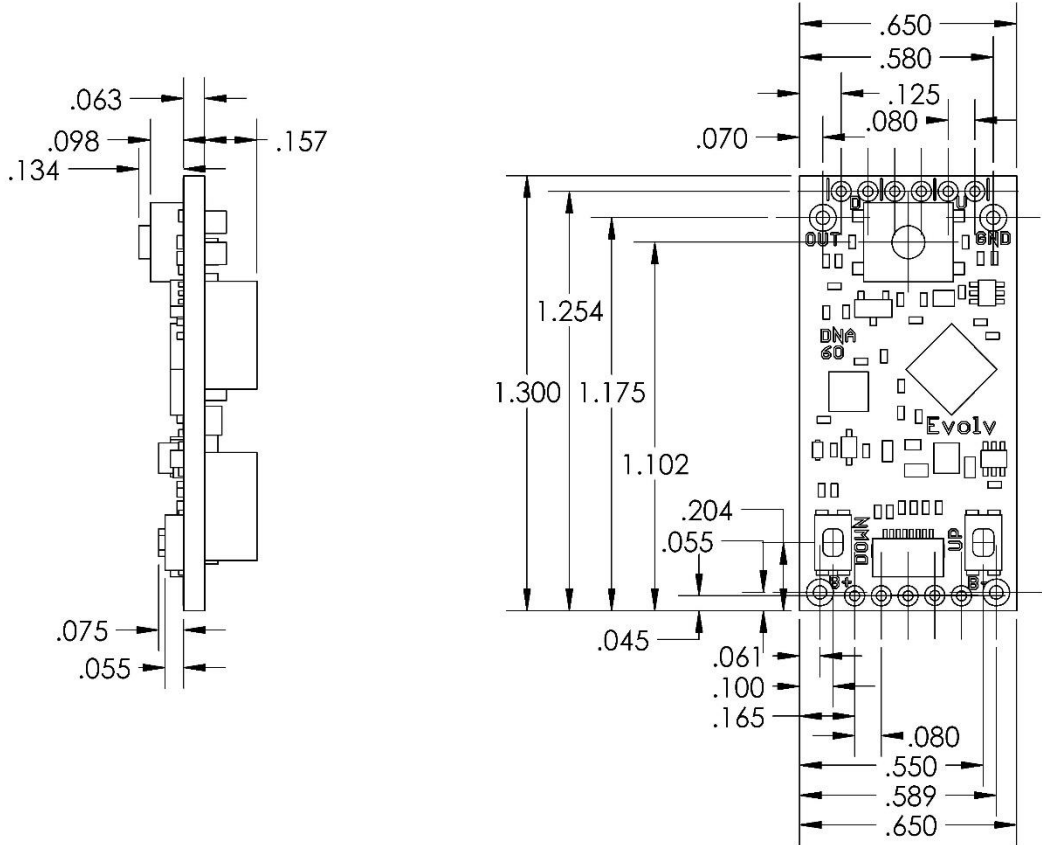

Evolv has 3D models of the DNA 60 available on their website in IGES, STP and Solidworks format.